



**INOVAÇÕES
TECNOLÓGICAS**

SEMEATO S.A.



Indústria de Máquinas Agrícolas



Especialista em semeadoras para o Sistema Plantio Direto



Empresa familiar – 100% nacional – Passo Fundo/RS



10 unidades fabris: RS e MG – 1800 colaboradores



Maior linha de semeadoras do mercado nacional



38% do mercado nacional



Exportação: 40 países



SEMEATO



HISTÓRIA



1965 : Mecânica Agrícola Rossato



Peças de Reposição



Máquinas para Plantio



1974: SEMEATO S.A.



Pioneira no Sistema Plantio Direto – Anos 70



Responsável pela Popularização do SPD



Investimento em Tecnologia







SEMEATO



PERFIL INOVADOR

PIONEIRISMO NO PLANTIO DIRETO

-  1977: SEMEATO e EMBRAPA-Trigo: Kit Disco de Corte
-  1980: 1ª semeadeira específica para Plantio Direto: TD
-  1986: 1ª plantadeira específica para Plantio Direto: PAR
-  1991: Facão Guilhotina: revolução no campo
-  1994: 1ª multisemeadora do Brasil: SHM



SISTEMA PLANTIO DIRETO



Sistema adotado pela empresa – Filosofia de trabalho





CONCEITO

Sistema de exploração agropecuária que envolve mobilização de solo apenas na linha de semeadura, cobertura permanente do solo e diversificação de espécies, via rotação de culturas.









PLANTIO DIRETO

PILARES DO SISTEMA

-  Mínima remoção do solo;
-  Cobertura permanente do solo;
-  Rotação de Culturas.



BENEFÍCIOS DO PLANTIO DIRETO

-  Redução de custos, combustíveis, custos operacionais;
-  Maior eficiência e maiores produtividades;
-  Reduz erosão do solo;
-  Melhora qualidade do ar e da água;
-  Sequestro de Carbono: diminui emissões de GEE;
-  Incremento de Matéria Orgânica no solo;
-  Conserva umidade do solo.



PLANTIO DIRETO

EVOLUÇÃO DA ÁREA DE PLANTIO DIRETO NO BRASIL

1992-2002

(milhões de hectares)

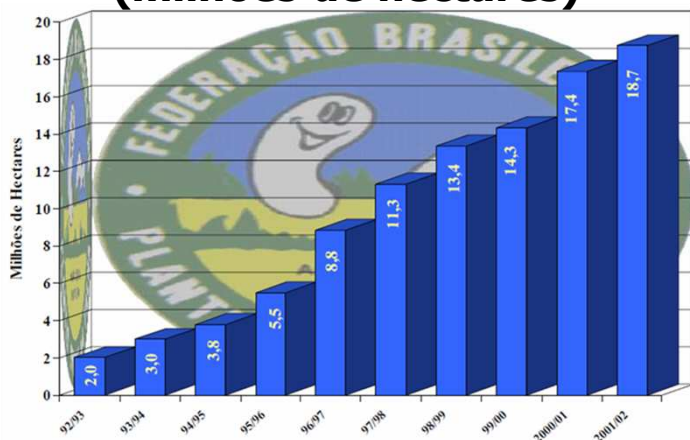

Fonte: Emater-RS, Epagri-SC, Emater-PR, Cati-SP, Fundação MS, APDC

2002-2011

(milhões de hectares)

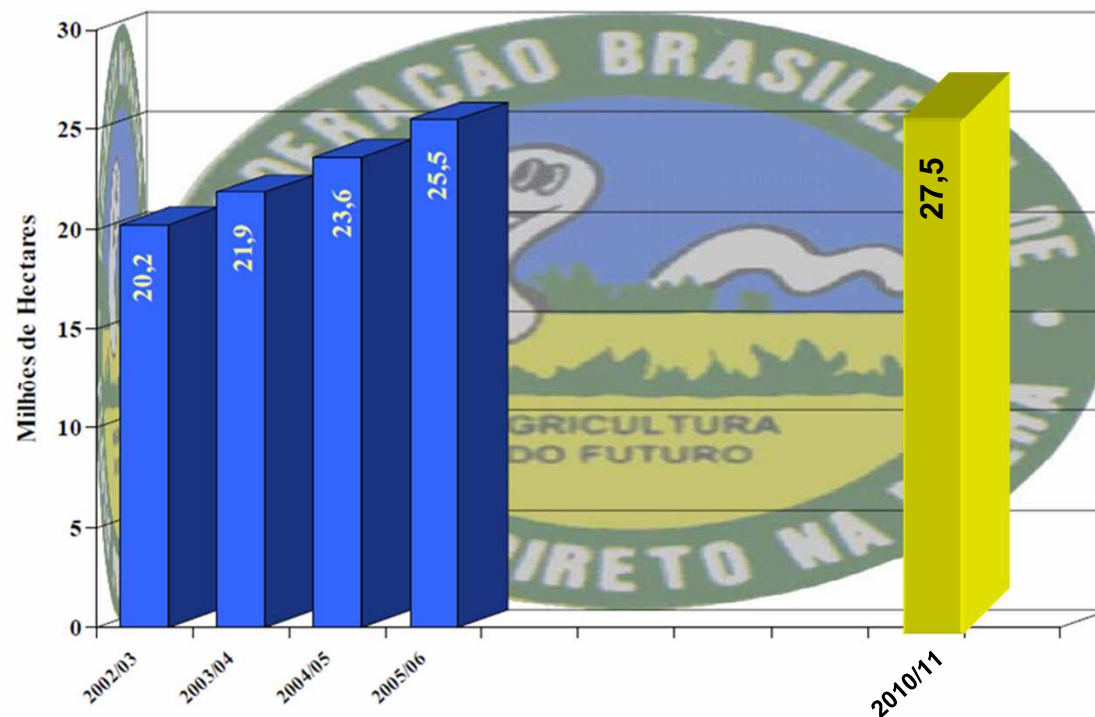

Fonte: Emater-RS, Epagri-SC, Emater-PR, Cati-SP, Fundação MS, APDC

PLANTIO DIRETO - INCENTIVO

PROGRAMA ABC

AGRICULTURA DE BAIXO CARBONO

PRÁTICAS PARA REDUÇÃO DAS EMISSÕES DE CO₂

R\$ 2 BILHÕES (5,5% a.a – 12 anos)



PLANTIO DIRETO: +8 milhões ha = -16/20 milhões t CO₂



RECUPERAÇÃO DE PASTAGENS: 15 milhões ha = -83/104 milhões t CO₂



INTEGRAÇÃO AGRIC.-PECUÁRIA: 4 milhões ha = -18/22 milhões t CO₂



SEMEATO



PLANTIO DIRETO



Atualmente o Sistema Plantio Direto é reconhecido pela FAO como o principal sistema de conservação de solo e água, incremento gradual de fertilidade do solo e redução significativa da necessidade de mecanização das áreas assim como o aumento da lucratividade da atividade agrícola.



O movimento nacional em prol da agricultura conservacionista está mobilizado para a criação de um “**selo verde**” e busca certificação das áreas com SPD, visando a remuneração dos produtores rurais usuários do sistema pelos serviços ambientais gerados nas suas propriedades.



P & D SEMEATO



Centro de P&D: unidade específica;



Tecnologia própria;



180 profissionais;



Investimento Anual: **8,5 %** (2011)
(média brasileira: 0,64% - ANPEI, 2005)

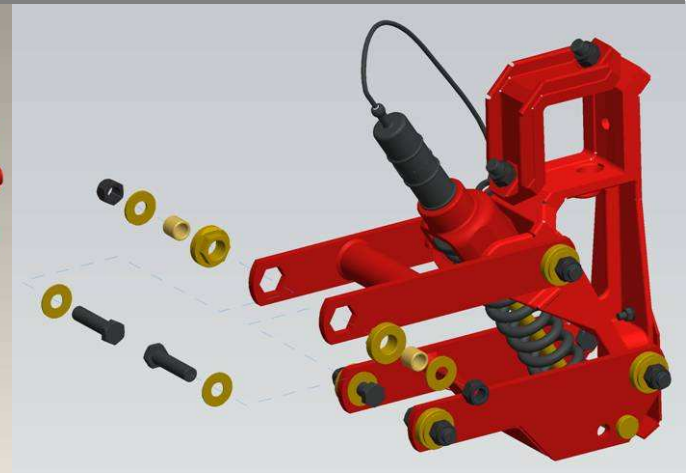
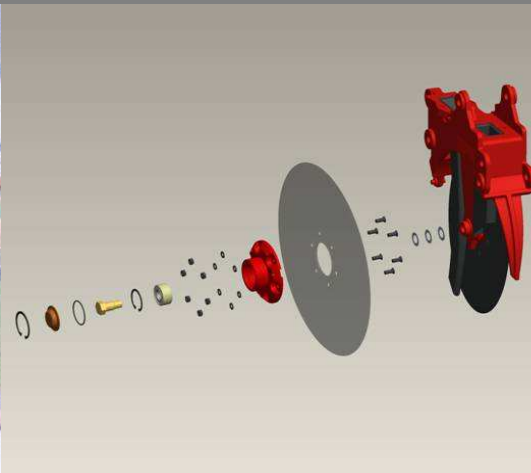

SEMEATO



LANÇAMENTOS NACIONAIS

SOL TT



POWERSIX 280

MULTI CROP 4100



SEMEATO



LANÇAMENTOS INTERNACIONAIS

RED SOLO

Semeadeira de Trigo

Mercado: Rússia, Ucrânia, Austrália

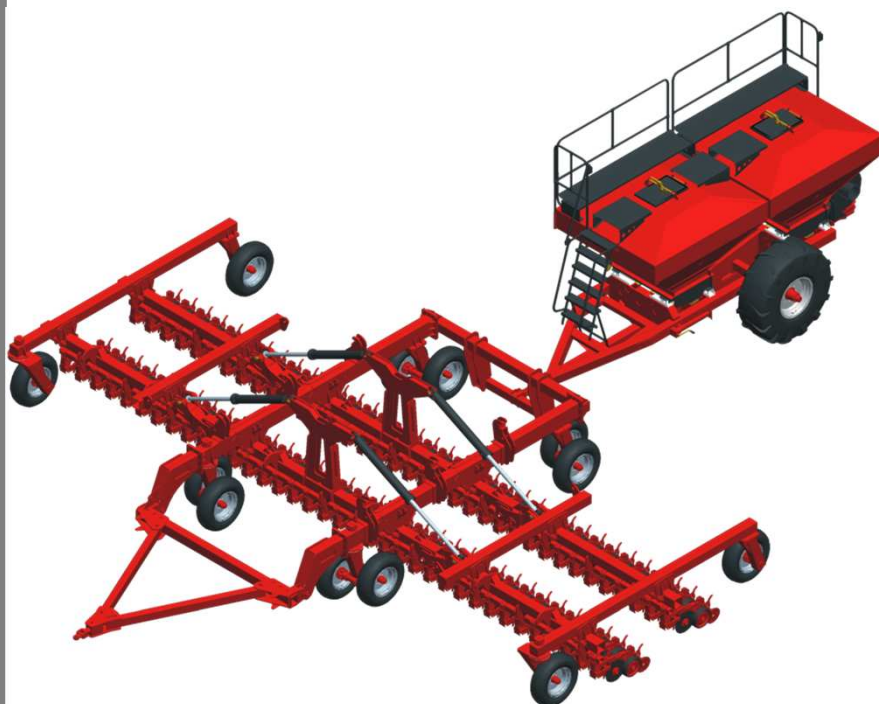

TDNG 450 AS

Semeadeira de Trigo

Mercado: Europa



SEMEATO



MARCAS E PATENTES SEMEATO



Departamento de Marcas e Patentes;



12 profissionais;



Comissão Técnica: engenheiros e técnicos.

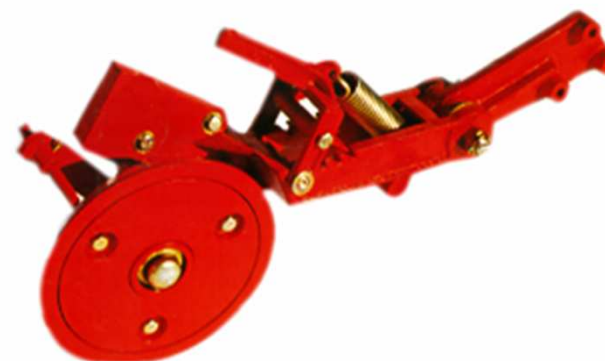

SEMEATO



MARCAS E PATENTES SEMEATO



Revista ÉPOCA

(agosto/2011)

"Nosso mercado é muito competitivo no Brasil. Precisamos criar sempre e as patentes são consequências disso".

Roberto O. Rossato

Diretor Presidente SEMEATO S.A.

As inovadoras

As instituições que mais registraram patentes no Brasil de 2000 a 2008

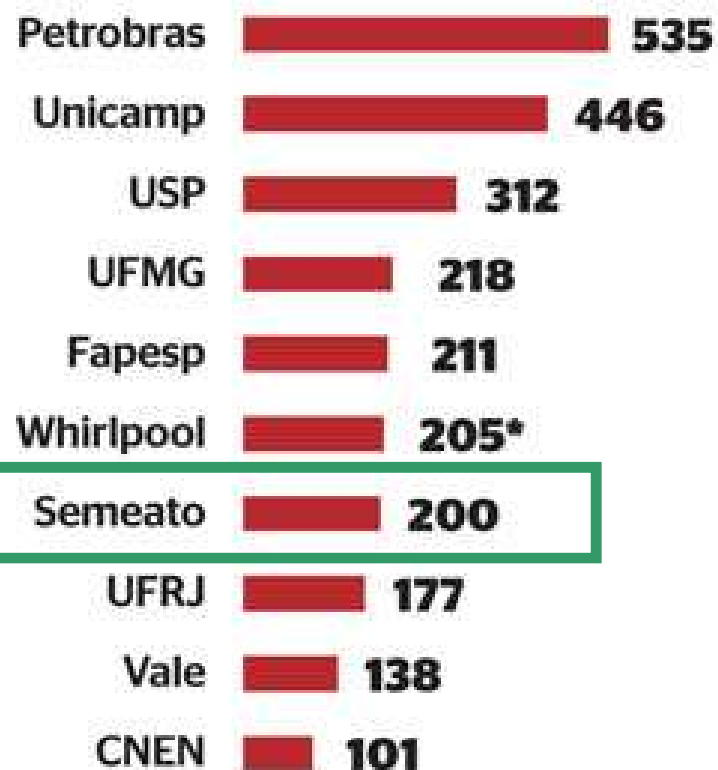

* Inclui Embraco e Multibrás a partir de 2004

SEMEATO



MARCAS E PATENTES SEMEATO



Número de Patentes Depositadas: **280**



Número de Patentes Depositadas no Exterior: **03**



Número de Marcas Registradas: **110**



Número de Marcas Registradas Exterior: **26**



Número de Desenhos Industriais: **38**

Fonte: Depto. Marcas e Patentes Semeato, 10/2011

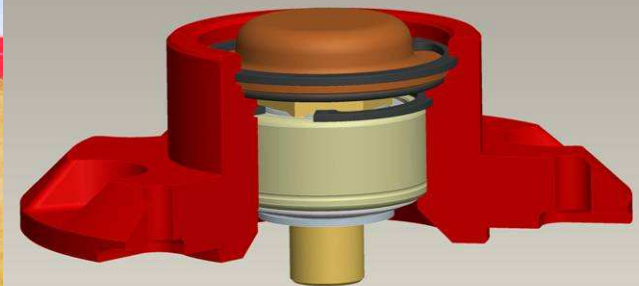

SEMEATO



MUITO OBRIGADO !



ENG.-AGR. EDUARDO COPETTI

Gerente Desenvolvimento Mercado/Produto

eduardo.copetti@semeato.com.br

SEMEATO

